

Surface Mount Superfast Recovery Rectifier

Reverse Voltage – 50 to 600 V

Forward Current –2 A

FEATURES

- For surface mounted applications
- Low profile package
- Glass Passivated Chip Junction
- Superfast reverse recovery time
- Lead free in comply with EU RoHS 2011/65/EU directives

MECHANICAL DATA

- Case: SMA
- Terminals: Solderable per MIL-STD-750, Method 2026
- Approx. Weight: 0.055g / 0.002oz

PINNING

- 1 Cathode
- 2 Anode

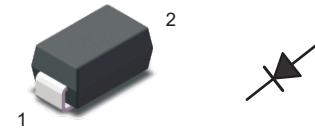

Top View
Marking Code: ES2A~ES2J
Simplified outline SMA and symbol

Absolute Maximum Ratings and Characteristics

Ratings at 25 °C ambient temperature unless otherwise specified. Single phase, half wave, 60 Hz, resistive or inductive load. For capacitive load, derate current by 20%.

Parameter	Symbols	ES2A	ES2B	ES2C	ES2D	ES2E	ES2G	ES2J	Units
Maximum Repetitive Peak Reverse Voltage	V_{RRM}	50	100	150	200	300	400	600	V
Maximum RMS voltage	V_{RMS}	35	70	105	140	210	280	420	V
Maximum DC Blocking Voltage	V_{DC}	50	100	150	200	300	400	600	V
Maximum Average Forward Rectified Current at $T_c = 125\text{ °C}$	$I_{F(AV)}$	2							A
Peak Forward Surge Current 8.3 ms Single Half Sine Wave Superimposed on Rated Load	I_{FSM}	50							A
Maximum Forward Voltage at 2 A	V_F	1				1.25		1.68	V
Maximum DC Reverse Current at Rated DC Blocking Voltage $T_a = 25\text{ °C}$ $T_a = 125\text{ °C}$	I_R	5 100							μA
Typical Junction Capacitance at $V_R=4\text{V}$, $f=1\text{MHz}$	C_j	40							pF
Maximum Reverse Recovery Time ⁽¹⁾	t_{rr}	35							ns
Typical Thermal Resistance ⁽²⁾	$R_{\theta JA}$	60							°C/W
Operating and Storage Temperature Range	T_j, T_{stg}	-55 ~ +150							°C

(1) Measured with $I_F = 0.5\text{ A}$, $I_R = 1\text{ A}$, $I_{rr} = 0.25\text{ A}$.

(2) P.C.B. mounted with 1.0 X 1.0" (2.54 X 2.54 cm) copper pad areas.

Fig.1 Reverse Recovery Time Characteristic And Test Circuit Diagram

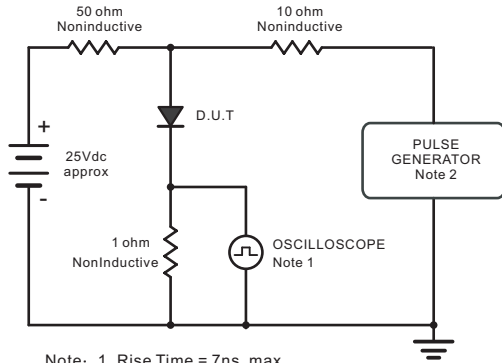

Note: 1. Rise Time = 7ns, max.
Input Impedance = 1megohm, 22pF.
2. Rises Time = 10ns, max.
Source Impedance = 50 ohms.

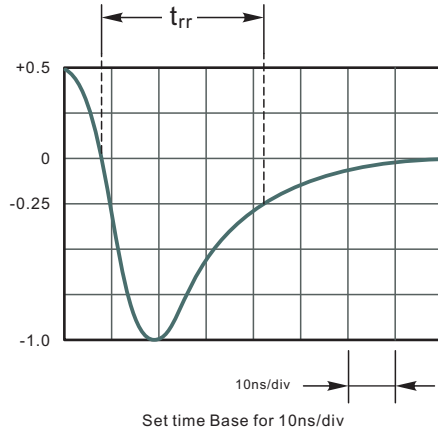

Fig.2 Maximum Average Forward Current Rating

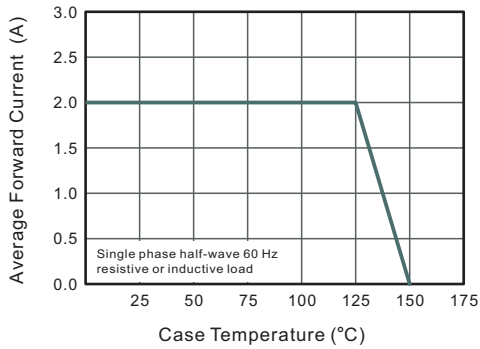

Fig.3 Typical Reverse Characteristics

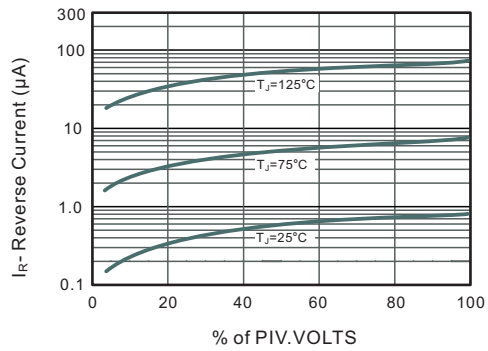

Fig.4 Typical Forward Characteristics

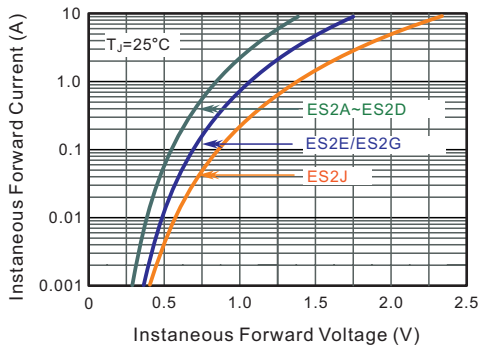

Fig.5 Typical Junction Capacitance

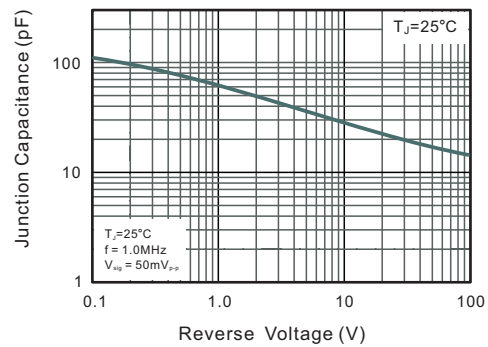
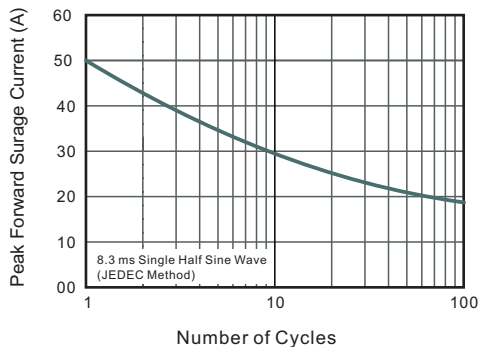

Fig.6 Maximum Non-Repetitive Peak Forward Surge Current



PACKAGE OUTLINE

Plastic surface mounted package; 2 leads

SMA

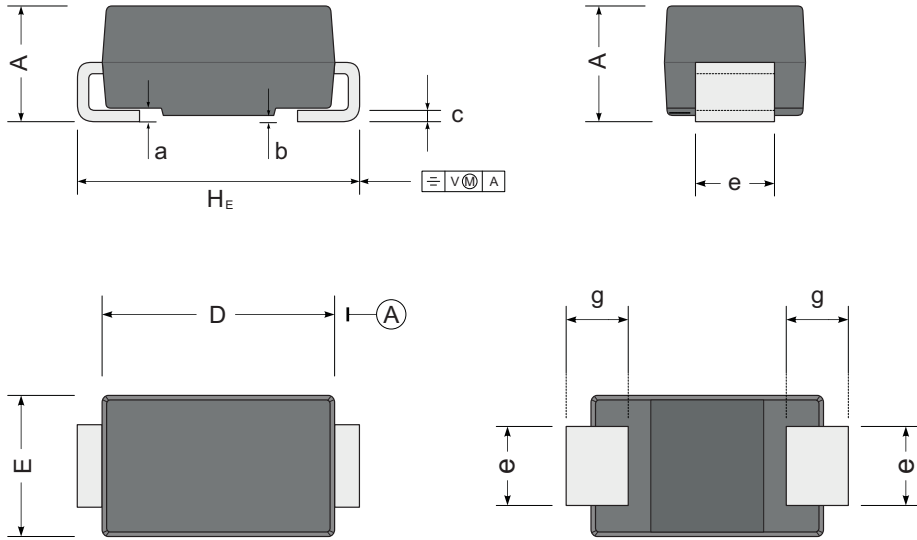

UNIT		A	D	E	H _E	c	e	g	b	a
mm	max	2.2	4.5	2.7	5.2	0.31	1.6	1.5	0.2	0.3
	min	1.9	4.0	2.3	4.7	0.15	1.3	0.9	0.05	
mil	max	87	181	106	205	12	63	59	7.9	12
	min	75	157	91	185	6	51	35	2	

The recommended mounting pad size

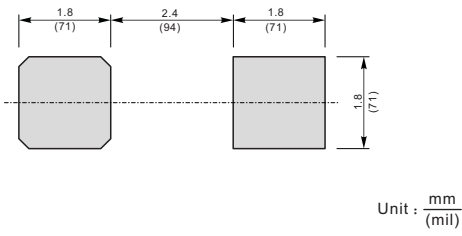

Marking

Type number	Marking code
ES2A	ES2A
ES2B	ES2B
ES2C	ES2C
ES2D	ES2D
ES2E	ES2E
ES2G	ES2G
ES2J	ES2J